

# SERVICE MANUAL

STEREO POWER AMPLIFIER

## SANSUI B-2101

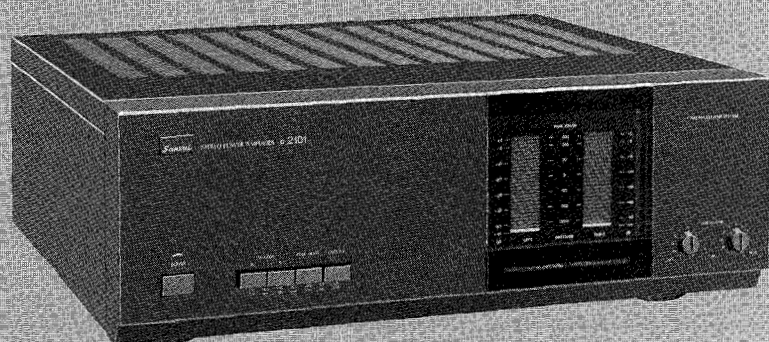

### CAUTION

1. Parts identified by the  $\triangle$  symbol on the schematic diagram and the parts list are critical for safety. Use only replacement parts that have critical characteristics recommended by the manufacturer.
2. Make leakage-current or resistance measurements to determine that exposed parts are acceptably insulated from the supply circuit before returning the appliance to the customer.

### •SPECIFICATIONS

#### Power output

Min. RMS, both channels driven, from 20 to 20,000 Hz, with no more than 0.003% total harmonic distortion.

200 watts per channel into 8 ohms

**Load impedance**..... 8 ohms

#### Total harmonic distortion

..... less than 0.003% at or below rated min. RMS power output

**Intermodulation distortion** (60 Hz: 7 kHz = 4:1, SMPTE method) ..... less than 0.003% at rated power output

#### Frequency response

(at 1 watt) ..... DC to 300,000 Hz,  
+0 dB, -3.0 dB

#### Input sensitivity and impedance

(at 1 kHz) ..... 1 V/50 kohms

#### Signal to noise ratio (short-circuit,

A-network) ..... 115 dB

#### Power requirements

Power voltage ..... 120/220/240V (50/60 Hz)  
For U.S.A. & Canada 120V (60 Hz)

Power consumption... 650 watts 750 VA Rated  
950 watts Maximum

**Dimensions** ..... 430 mm (16-15/16") W  
160 mm (6-5/16") H  
412 mm (16-1/4") D

**Weight** ..... 18.0 kg (39.7 lbs) net  
19.5 kg (43.0 lbs) packed

\* Design and specifications subject to changes without notice for improvements.

**Sansui**

SANSUI ELECTRIC CO., LTD.

## CAUTION

1. The symbols, UL, CSA, SA, BS, UK, EU, AS and XX (EXPORT) on the parts list and the schematic diagram mean followings respectively.
  - UL..... Manufactured for U.S.A market.  
(Underwriters Laboratories approved model.)
  - CSA ..... Manufactured for Canadian market.
  - SA..... Manufactured for South African market.
  - BS, UK ..... Manufactured for United Kingdom market.
  - EU ..... Manufactured for European market.
  - AS..... Manufactured for Australian market.
  - XX (EXPORT) ..... Standard Version.
  - NON MARK ..... Common Parts.
  
2. Some printed circuit boards are not supplied as the assembled. To separate these in this service manual, the stock No's are not indicated at the ends of the board names. However, the individual parts on the circuit boards are provided by orders.
  
3. Since some of capacitors and resistors are omitted from parts lists in this service manual, refer to the Common Parts List for capacitors & resistors, which was issued on February 1983.
  
4. Abbreviations in this service manual are as follows.

### •Abbreviations List

C.R. : Carbon Resistor	E.B.L. : Low Leak Bi-Polar Electrolytic Capacitor
S.R. : Solid Resistor	Ta.C. : Tantalum Capacitor
Ce.R. : Cement Resistor	F.C. : Film Capacitor
M.R. : Metal Film Resistor	M.P. : Metalized Paper Capacitor
F.R. : Fusing Resistor	P.C. : Polystyrene Capacitor
N.I.R. : Non-Inflammable Resistor	G.C. : Gimmic Capacitor
A.R. : Array Resistor	A.C. : Array Capacitor
C.C. : Ceramic Capacitor	V.R. : Variable Resistor
C.T. : Ceramic Capacitor, Temperature Compensation	S.V.R. : Semi Variable Resistor
E.C. : Electrolytic Capacitor	SW. : Switch
E.L. : Low Leak Electrolytic Capacitor	Chip R. : Chip Resistor
E.B. : Bi-Polar Electrolytic Capacitor	Chip C. : Chip Capacitor

# 1. BLOCK DIAGRAM

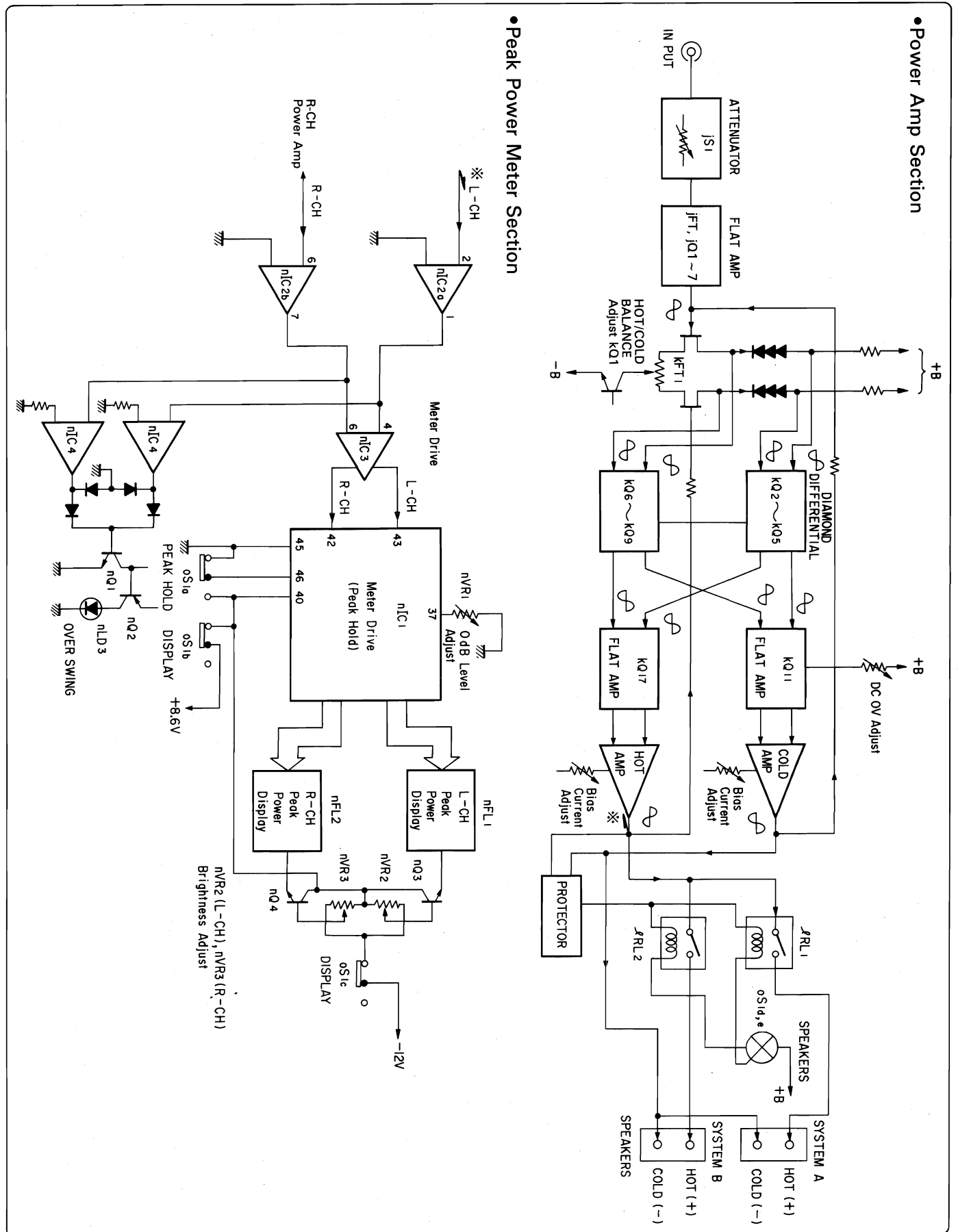

## 2. ADJUSTMENTS

- Notes:** 1. Room Temperature ..... 18°C~28°C (65°F~83°F)  
 2. For this adjustment, run the unit for more than 20 minutes after the power is switched ON.  
 3. Load ..... None

### 2-1. F-4618 Flat Amp. Circuit Board Adjustment (See Top View on page 8)

STEP	SUBJECT	MEASURE OUTPUT	ADJUST	ADJUST FOR	REMARKS
1.	Center DC 0V Adj. <L-CH>	DC Voltage between Test Point & GND of F-4618 L-CH.	jVR1 (F-4618)	DC 0V ± 5 mV	•Attenuater Switch ..... MIN
2.	Center DC 0V Adj. <R-CH>	DC Voltage between Test Point & GND of F-4618 R-CH.	jVR1 (F-4618)	DC 0V ± 5 mV	

### 2-2. F-4618/F-4619 Driver & Power Amp. Circuit Board Adjustment (See Top View on page 8)

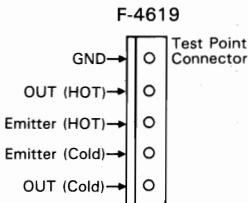
STEP	SUBJECT	MEASURE OUTPUT	ADJUST	ADJUST FOR	REMARKS
1.	Hot/Cold Balance Adj. <L-CH>	DC Voltage between Test Point OUT (HOT) and OUT (COLD) of F-4619 <L-CH>	kVR1 (F-4618) L-CH	DC 0V ± 5 mV	•Attenuater Switch ..... MIN •After adjustment step 4, repeat step 1, 2.  
2.	Hot/Cold Balance Adj. <R-CH>	DC Voltage between Test Point OUT (HOT) and OUT (COLD) of F-4619 <R-CH>	kVR1 (F-4618) R-CH	DC 0V ± 5 mV	
3.	Center DC 0V Adj. <L-CH>	DC Voltage between Test Point OUT (HOT) and GND of F-4619 <L-CH>	kVR2 (F-4618) L-CH	DC 0V ± 5 mV	
4.	Center DC 0V Adj. <R-CH>	DC Voltage between Test Point OUT (HOT) and GND of F-4619 <R-CH>	kVR2 (F-4618) R-CH	DC 0V ± 5 mV	
5.	Bias Current Adj. <Hot Side Amp. of L-CH>	DC Voltage between Test Point OUT (HOT) and Emitter (HOT) of F-4619 <L-CH>	kVR3 (F-4619) L-CH	DC 6.6 mV (30 mA) ± 2 mV	
6.	Bias Current Adj. <Cold Side Amp. of L-CH>	DC Voltage between Test Point OUT (COLD) and Emitter (COLD) of F-4619 <L-CH>	kVR4 (F-4619) L-CH	DC 6.6 mV (30 mA) ± 2 mV	
7.	Bias Current Adj. <Hot Side Amp. of R-CH>	DC Voltage between Test Point OUT (HOT) and Emitter (HOT) of F-4619 <R-CH>	kVR3 (F-4619) R-CH	DC 6.6 mV (30 mA) ± 2 mV	
8.	Bias Current Adj. <Cold Side Amp. of R-CH>	DC Voltage between Test Point OUT (COLD) and Emitter (COLD) of F-4619 <R-CH>	kVR4 (F-4619) R-CH	DC 6.6 mV (30 mA) ± 2 mV	

### 2-3. Peak Power Display Adjustment (See Top View on page 8)

- Notes:** 1. Attenuater ..... MAX  
 2. Load ..... 8Ω

STEP	SUBJECT	FEED SIGNAL		MEASURE OUTPUT	ADJUST	ADJUST FOR	REMARKS
		FROM	TO				
1.	0 dB Level Adjustment L-CH & R-CH	O.S.C. output 1 kHz so as to obtain 40V (200W) between Speaker Terminals HOT & COLD L-CH & R-CH	INPUT Terminal L-CH & R-CH	Peak Power Display L-CH & R-CH	nVR1 (F-4622)	Display Level 0 dB	•Remove the front panel for adjustment of nVR1, nVR2 & nVR3
2.	Brightness Adjustment	Same as above	Same as above	Same as above	nVR2 (L-CH) or nVR3 (R-CH)	Turn both volume to obtain maximum brightness. Then adjust one volume on brighter channel to obtain equal brightness with the other channel.	

### 3. PARTS LOCATION & PARTS LIST

#### 3-1. F-4618 Drive Amp Circuit Board (Stock No. 00829001)

Component Side

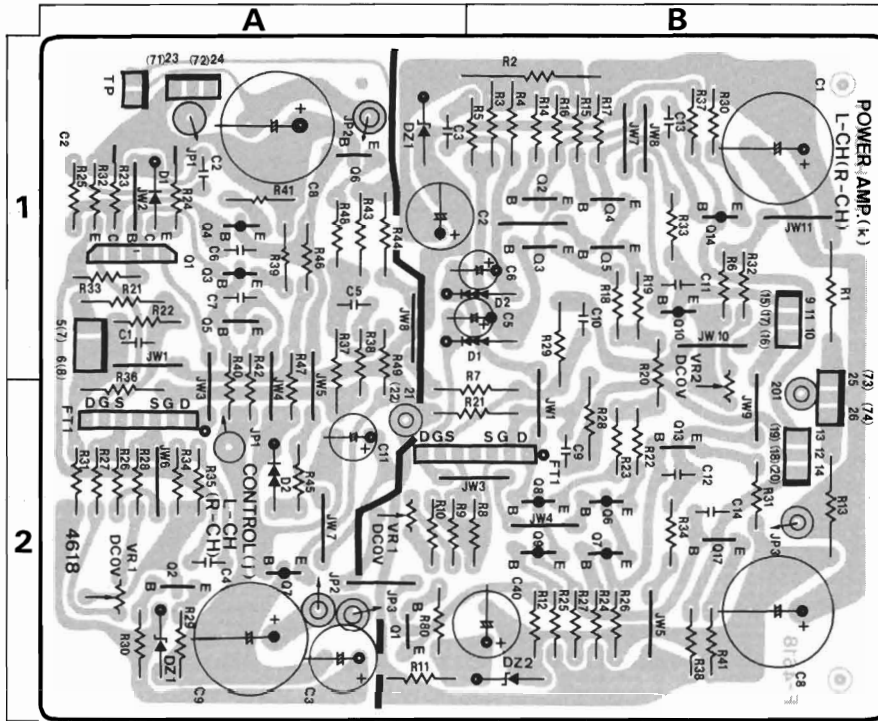

**Parts List**

Parts No.	Stock No.	Description
<b>•Transistor</b>		
jQ1	03068801	2SC2291
jQ2	46581701	2SC1845
jQ3	46581601	2SA992
jQ4	46581601	2SA992
jQ5	46581701	2SC1845
jQ6	46728301	2SC2705
jQ7	46728201	2SA1145
<b>•FET</b>		
jFT1	07110000 or 07110001	UPA68H-L UPA68H-M
<b>•Diode</b>		
jD1	03111800 or 03117600	1S1588 1S2473T77
jD2	03401500	Varistor MV12
<b>•Zener Diode</b>		
jDZ1	46111800	05Z6.2-Y
jR21	46014400	82Ω 1/2W C.R.
jR36	46019600	12kΩ 1/2W C.R.
jR37	46020400	27kΩ 1/2W C.R.
jR43	46004500	680Ω 1/2W C.R.
jR44	46002700	120Ω 1/2W C.R.
jVR1	10335700	100Ω (B) S.V.R., Center DC 0V
<b>•Transistor</b>		
kQ1	46581701	2SC1845
kQ2	46581701	2SC1845
kQ3	46581701	2SC1845
kQ4	46581701	2SC1845
kQ5	46581701	2SC1845
kQ6	46581601	2SA992

Parts No.	Stock No.	Description
kQ7	46581601	2SA992
kQ8	46581601	2SA992
kQ9	46581601	2SA992
kQ10	46728201	2SA1145
kQ13	46728301	2SC2705
kQ14	46728201	2SA1145
kQ17	46728301	2SC2705
<b>•FET</b>		
kFT1	07110000 or 07110001	UPA68H-L UPA68H-M
kD1	03401700	Varistor MV103
kD2	03401700	Varistor MV103
<b>•Zener Diode</b>		
kDZ1	03171900	RD27FB
kDZ2	46114800	05Z16-Y
△ KR1	00134100	33Ω 1/2W N.I.R.
KR2	00191400	680Ω 2W N.I.R.
KR6	00133600	270kΩ 1/2W N.I.R.
KR7	46006300	3.9kΩ 1/2W C.R.
KR13	00134100	33Ω 1/2W N.I.R.
KR21	46006500	4.7kΩ 1/2W C.R.
KR28	46009200	62kΩ 1/2W C.R.
KR29	46009200	62kΩ 1/2W C.R.
△ KR30	00131500	120Ω 1/2W N.I.R.
△ KR31	00131500	120Ω 1/2W N.I.R.
△ KR32	00132500	180Ω 1/2W N.I.R.
△ KR42	00131500	120Ω 1/2W N.I.R.
kVR1	10335700	100Ω (B) S.V.R., Hot/Cold Balance
kVR2	10336100	470Ω (B) S.V.R., DC 0V

3-2. F-4619 Power Amp Circuit Board (Stock No. 00829101)

Component Side

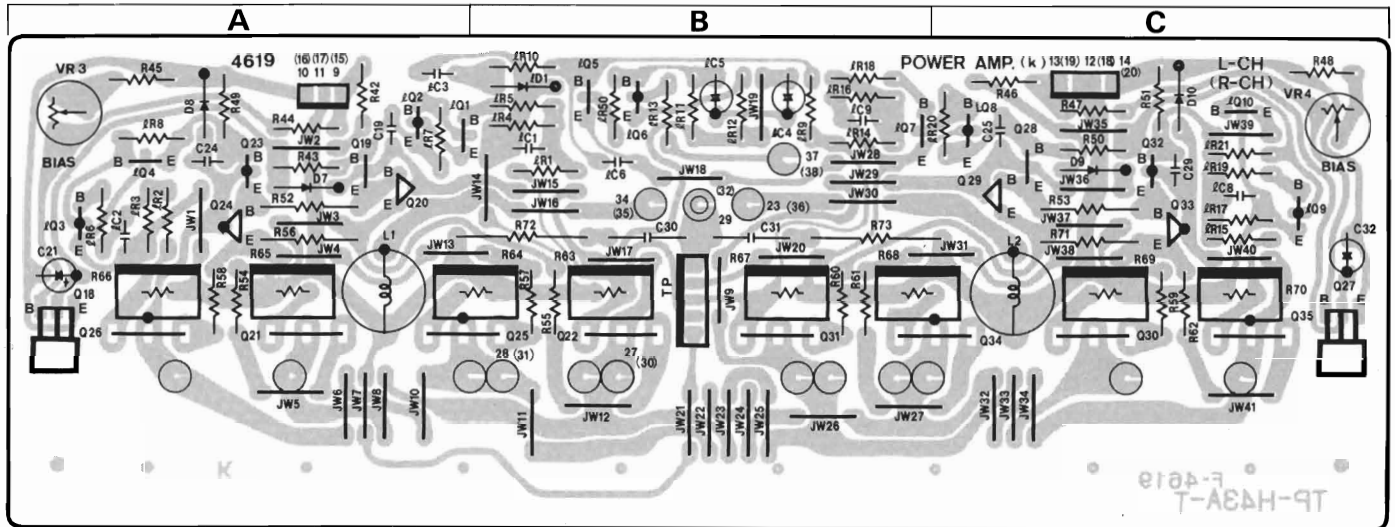

Parts List

Parts No.	Stock No.	Description	Parts No.	Stock No.	Description
<b>•Transistor</b>			<b>•Transistor</b>		
△ kQ18	03067401	2SC1845	△ kR66	46542800	22Ω 5W Ce. R
kQ19	07208701	2SC2705	kR67	46542800	22Ω 5W Ce. R
kQ20	46728901	2SC3298	kR68	46542800	22Ω 5W Ce. R
△ kQ21	46729901	2SC3519	△ kR69	46542800	22Ω 5W Ce. R
△ kQ22	46729901	2SC3519	△ kR70	46542800	22Ω 5W Ce. R
kQ23	07208801	2SA1145	△ kR71	00131500	120Ω 1/2W N.I.R.
kQ24	46728801	2SA1306	△ kR72	00185500	10Ω 2W N.I.R.
△ kQ25	46729801	2SA1386	△ kR73	00185500	10Ω 2W N.I.R.
△ kQ26	46729801	2SA1386	kC30	00411600	0.047μF 400V P.C.
△ kQ27	03067401	2SC1845	kC31	00411600	0.047μF 400V P.C.
kQ28	07208701	2SC2705	kL1	46851900	Inductor 0.8μH
kQ29	46728901	2SC3298	kL2	46851900	Inductor 0.8μH
△ kQ30	46729901	2SC3519	kVR3	10342100	1kΩ(B) S.V.R., Bias Adjust
△ kQ31	46729901	2SC3519	kVR4	10342100	1kΩ(B) S.V.R., Bias Adjust
kQ32	07208801	2SA1145	<b>•Transistor</b>		
△ kQ33	46728801	2SA1306	IQ1	46367101	2SC2603
△ kQ34	46729801	2SA1386	IQ2	46367001	2SA1115
△ kQ35	46729801	2SA1386	IQ3	46367001	2SA1115
<b>•Diode</b>			IQ4	46367101	2SC2603
kD7	46727900	1S2091	IQ5	46367101	2SC2603
kD8	46727900	1S2091	IQ6	46367001	2SA1115
kD9	46727900	1S2091	IQ7	46367101	2SC2603
kD10	46727900	1S2091	IQ8	46367001	2SA1115
△ kR52	00136000	560Ω 1/2W N.I.R.	IQ9	46367001	2SA1115
△ kR53	00136000	560Ω 1/2W N.I.R.	IQ10	46367101	2SC2603
△ kR54	00135800	4.7Ω 1/2W N.I.R.	<b>•Diode</b>		
△ kR55	00135800	4.7Ω 1/2W N.I.R.	ID1	03117600	1S2473T77
△ kR56	00131500	120Ω 1/2W N.I.R.	or	46086000	1S1588TP-3
△ kR57	00135800	4.7Ω 1/2W N.I.R.	IC1	46655600	1000pF 100V F.C.
△ kR58	00135800	4.7Ω 1/2W N.I.R.	IC2	46655600	1000pF 100V F.C.
△ kR59	00135800	4.7Ω 1/2W N.I.R.	IC3	46654800	470pF 100V F.C.
△ kR60	00135800	4.7Ω 1/2W N.I.R.	IC6	46283300	0.022μF 50V F.C.
△ kR61	00135800	4.7Ω 1/2W N.I.R.	IC8	46655600	1000pF 100V F.C.
kR63	46542800	22Ω 5W Ce. R.	IC9	46655600	1000pF 100V F.C.
kR64	46542800	22Ω 5W Ce. R.			
△ kR65	46542800	22Ω 5W Ce. R.			

3-3. F-4620 Protector Circuit Board (Stock No. 00829201)

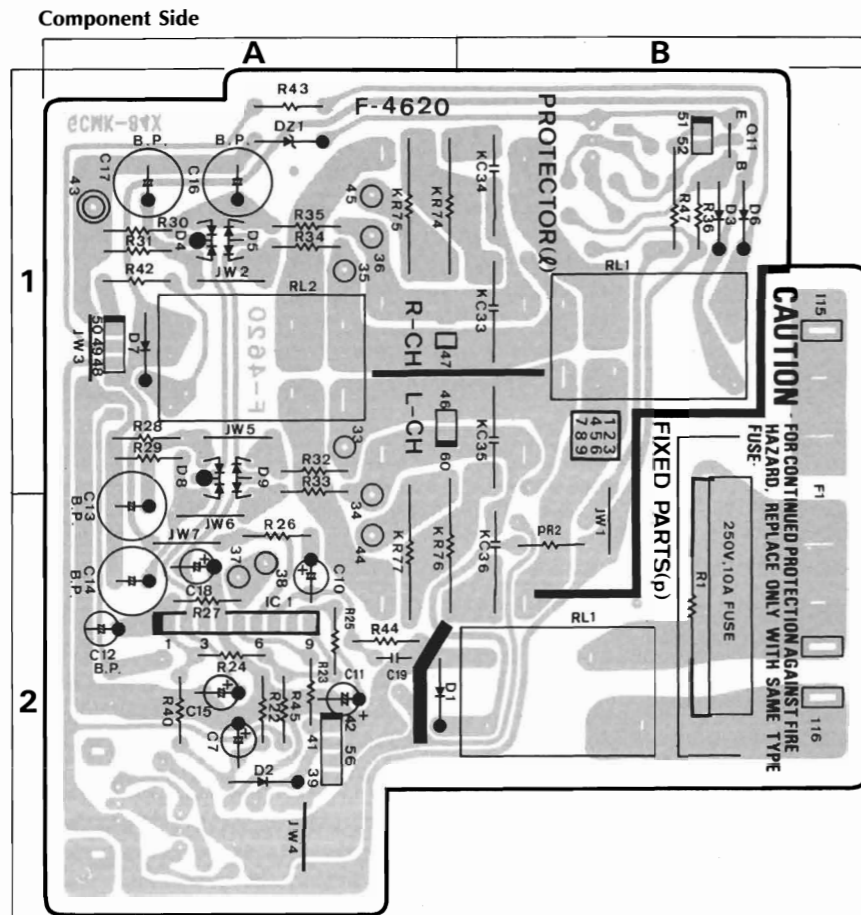

Parts List

Parts No.	Stock No.	Description
△ KR42	00130800	10Ω 1/2W N.I.R.
△ KR43	00130800	10Ω 1/2W N.I.R.
△ KR47	46243900	1.8kΩ 1W N.I.R.
△ KR74	00185500	10Ω 2W N.I.R.
△ KR75	00185500	10Ω 2W N.I.R.
△ KR76	00185500	10Ω 2W N.I.R.
△ KR77	00185500	10Ω 2W N.I.R.
KC33	00411600	0.047μF 400V P.C.
KC34	00411600	0.047μF 400V P.C.
KC35	00411600	0.047μF 400V P.C.
KC36	00411600	0.047μF 400V P.C.
• Transistor		
IQ11	07194801	2SC1815
• IC		
IIC1	46207600	TA7317P
• Diode		
ID2	03117700	10E-2
ID3	03111800	1S1588
	or 07176400	1S2473HS
ID4	46463700	MC911
ID5	46463900	MC921
ID6	03117700	10E-2
ID7	03117700	10E-2
ID8	46463700	MC911
ID9	46463900	MC921

Parts No.	Stock No.	Description
• Zener Diode		
IDZ1	46104100	05Z6.2-Y
	or 46101700	05Z6.2-Z
IC12	07129900	1μF 50V E.B.
IC13	08460800	100μF 10V E.B.
IC14	08460800	100μF 10V E.B.
IC16	08460800	100μF 10V E.B.
IC17	08460800	100μF 10V E.B.
△ IC19	00382600	220pF 50V C.C.
IRL1	46446400	Relay JC24V
IRL2	46446400	Relay JC24V
	46739500	8P Speaker Terminal
• Diode		
pD1	03117700	10E-2
△ pR1	46739900	3.9Ω 10W Ce.R.
△ pR2	00130800	10Ω 1/2W N.I.R.
△ pRL1	46222200	Relay 1M G4W
△ pF3	07189500	10A 250V AC Fuse <UL, CSA>
△	07185300	4A 250V AC Fuse <EU>

3-4. F-4622 Peak Power Display Circuit Board (Stock No. 00829401)

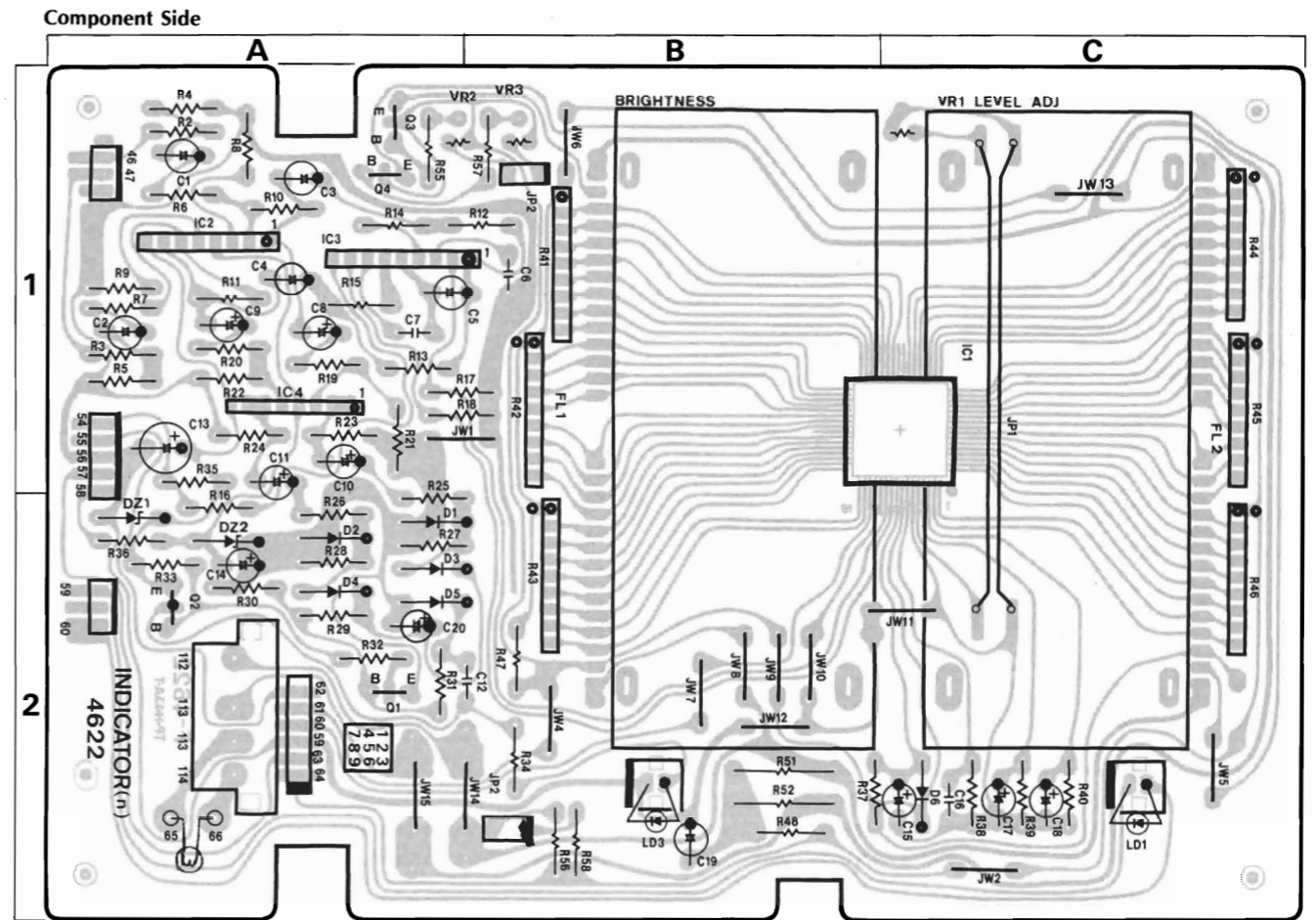

Parts List

Parts No.	Stock No.	Description
• Transistor		
nQ1	46367101	2SC2603
nQ2	46367001	2SA1115
nQ3	46188701	2SC1815
nQ4	46188701	2SC1815
• IC		
nIC1	48118100	LC7550
nIC2	46078900	M5218L
nIC3	03610000	TA7318P
nIC4	46078900	M5218L
• Diode		
nD1	03117600	1S2473T77
	or 46086000	1S1588TP-3
nD2	03117600	1S2473T77
	or 46086000	1S1588TP-3
nD3	03117600	1S2473T77
	or 46086000	1S1588TP-3
nD4	03117600	1S2473T77
	or 46086000	1S1588TP-3
nD5	03117600	1S2473T77
	or 46086000	1S1588TP-3
nD6	03117600	1S2473T77
	or 46086000	1S1588TP-3
• Zener Diode		
nDZ1	46114200	05Z13-Y
	or 46114300	05Z13-Z
nDZ2	46114200	05Z13-Y
	or 46114300	05Z13-Z

Parts No.	Stock No.	Description
nFL1	48112500	Display Tube FGS25SA1
nFL2	48112500	Display Tube FGS25SA1
nLD2	03193700	LED SEL1110S
nLD3	03193700	LED SEL1110S
nR41	46047100	100kΩ × 8 1/8W A.R.
nR42	46047100	100kΩ × 8 1/8W A.R.
nR43	46047100	100kΩ × 8 1/8W A.R.
nR44	46047100	100kΩ × 8 1/8W A.R.
nR45	46047100	100kΩ × 8 1/8W A.R.
nR46	46047100	100kΩ × 8 1/8W A.R.
△ nR48	00136500	68Ω 1/2W N.I.R.
△ nR51	46241200	10Ω 1W N.I.R.
△ nR52	46241200	10Ω 1W N.I.R.
nC1	08451700	1μF 50V E.B.
nC2	08451700	1μF 50V E.B.
nC3	08451700	1μF 50V E.B.
nC4	08451700	1μF 50V E.B.
nC5	08451700	1μF 50V E.B.
nC6	46282900	0.01μF 50V F.C.
nC7	46282900	0.01μF 50V F.C.
nC12	46284100	0.1μF 50V F.C.
nC19	08451000	10μF 16V E.B.
nVR1	46841000	22kΩ S.V.R., 0 dB Level
nVR2	46840800	4.7kΩ S.V.R., Brightness (L-CH)
nVR3	46840800	4.7kΩ S.V.R., Brightness (R-CH)

3-5. F-4627 Power Supply Circuit Board (Stock No. 00829901)

Component Side

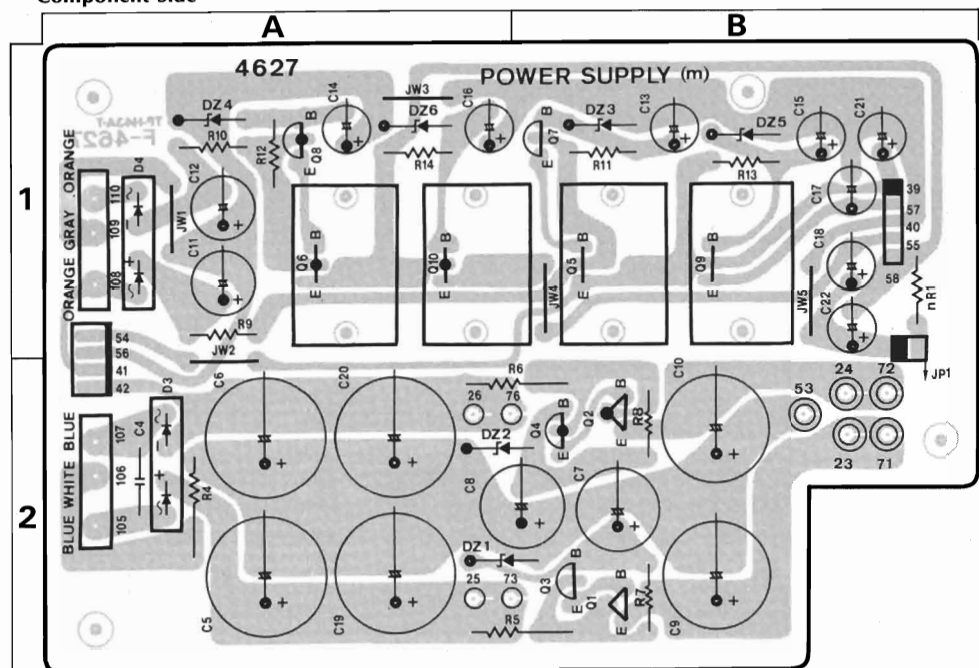

Parts List

Parts No.	Stock No.	Description
•Transistor		
△ mQ1	46728901	2SC3298
△ mQ2	46728801	2SA1306
mQ3	03067401	2SC1845
mQ4	03010901	2SA992
△ mQ5	03086101	2SD357
△ mQ6	03034401	2SB527
mQ7	03067401	2SC1845
mQ8	03010901	2SA992
mQ9	03086101	2SD357
mQ10	03034401	2SB527
•Diode		
△ mD3	07193300	UB-152LFF
△ mD4	03117000	RB152-LFF

Parts No.	Stock No.	Description
•Zener Diode		
mDZ1	46106700	05Z33-Y
mDZ2	46106700	05Z33-Y
mDZ3	46105800	05Z24-Y
mDZ4	46105800	05Z24-Y
mDZ5	46102800	05Z9.1-Y
	or 46102900	05Z9.1-Z
mDZ6	46103700	05Z12-Y
	or 46103800	05Z12-Z
mC4	07287400	0.01μF 630V C.C.
△ mR5	00130800	10Ω 1/2W N.I.R.
△ mR6	00130800	10Ω 1/2W N.I.R.
△ mR9	00130800	10Ω 1/2W N.I.R.
△ mR10	00130800	10Ω 1/2W N.I.R.

3-6. F-4623 Speaker Switch Circuit Board

Component Side

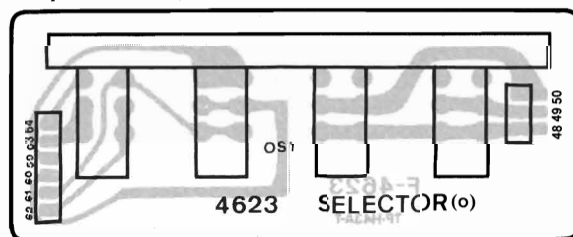

Parts List

Parts No.	Stock No.	Description
oS1	48112000	Push SW., SPEAKERS/PEAK HOLD/DISPLAY

3-7. F-4625 Input Terminal Circuit Board

Component Side

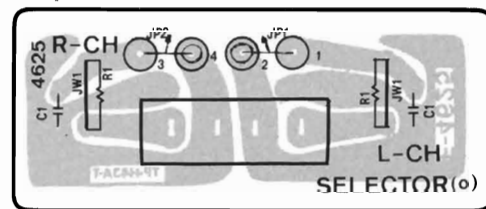

Parts List

Parts No.	Stock No.	Description
	22006100	2P Input Terminal Board

3-8. F-4624 Control Circuit Board

Component Side

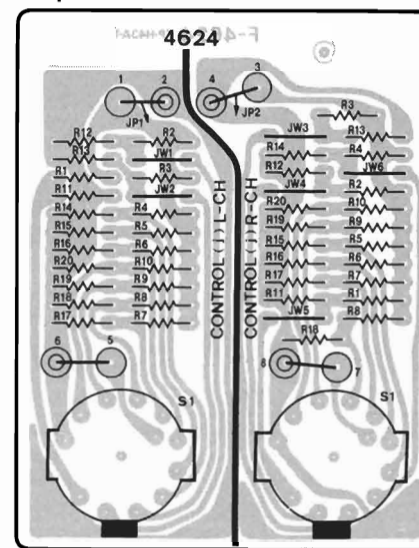

Parts List

Parts No.	Stock No.	Description
JS1	48112100	Rotary SW., ATTENUATOR

3-10. F-4628 AC Fuse Circuit Board

Component Side

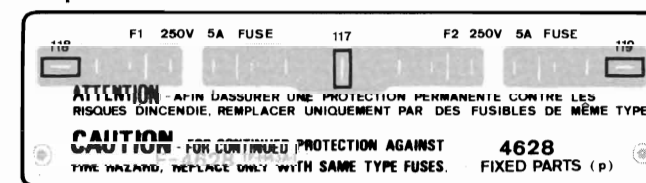

Parts List

Parts No.	Stock No.	Description
△ pF1	07189100	AC Fuse 5A 250V <XX>
△ pF2	07189100	AC Fuse 5A 250V <XX>

3-9. F-4626 Power Supply Circuit Board

Component Side

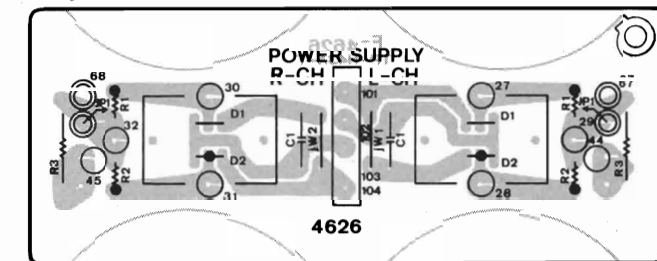

Parts List

Parts No.	Stock No.	Description
•Diode		
△ mD1	46731400	CTP-21R
△ mD2	46731500	CTP-21S
△ mR1	00150600	6.8kΩ 2W N.I.R.
△ mR2	00150600	6.8kΩ 2W N.I.R.
mC1	07287400	0.01μF 630V C.C.

3-11. F-4731 Power Indicator Circuit Board

Component Side

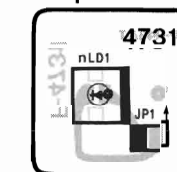

Parts List

Parts No.	Stock No.	Description
nLD1	03193700	LED SEL1110S



### 4. OTHER PARTS

4-1. Front View

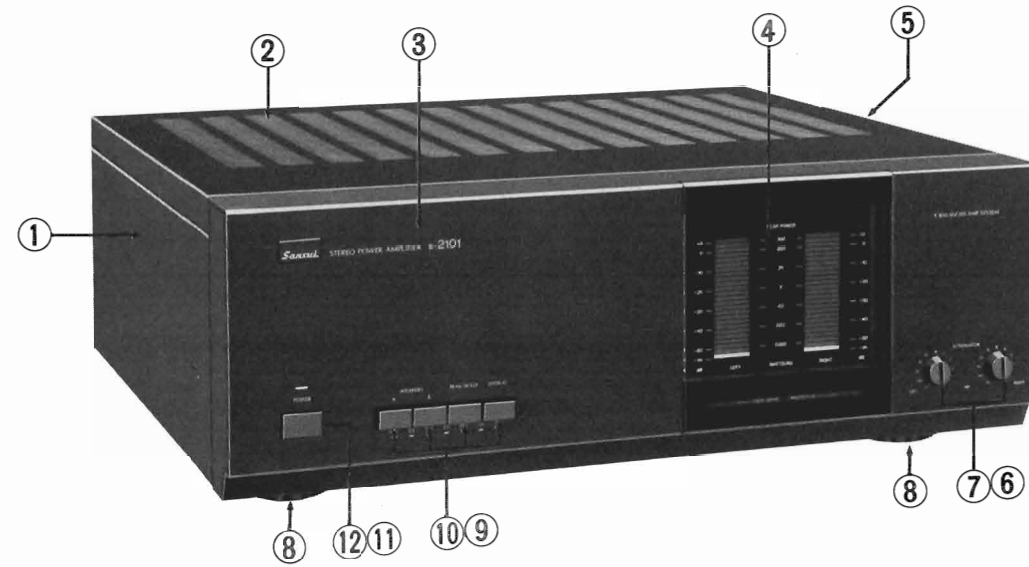

4-3. Rear View

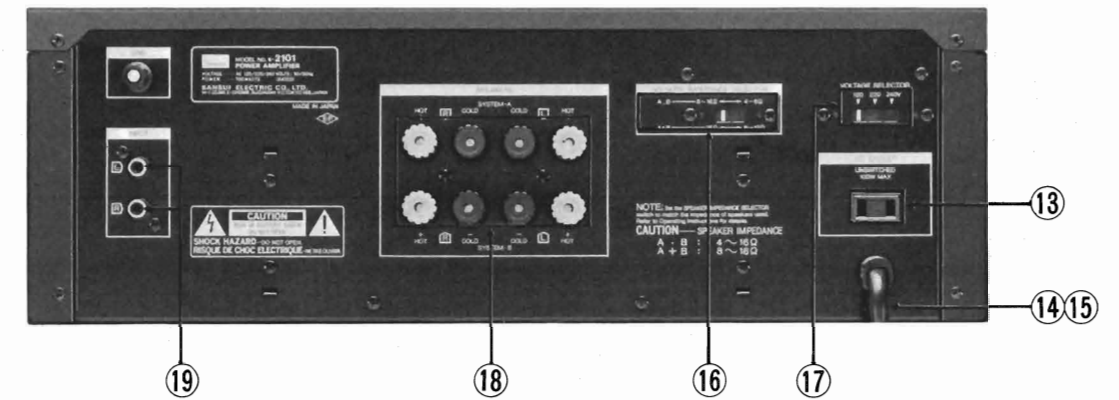

4-2. Top View

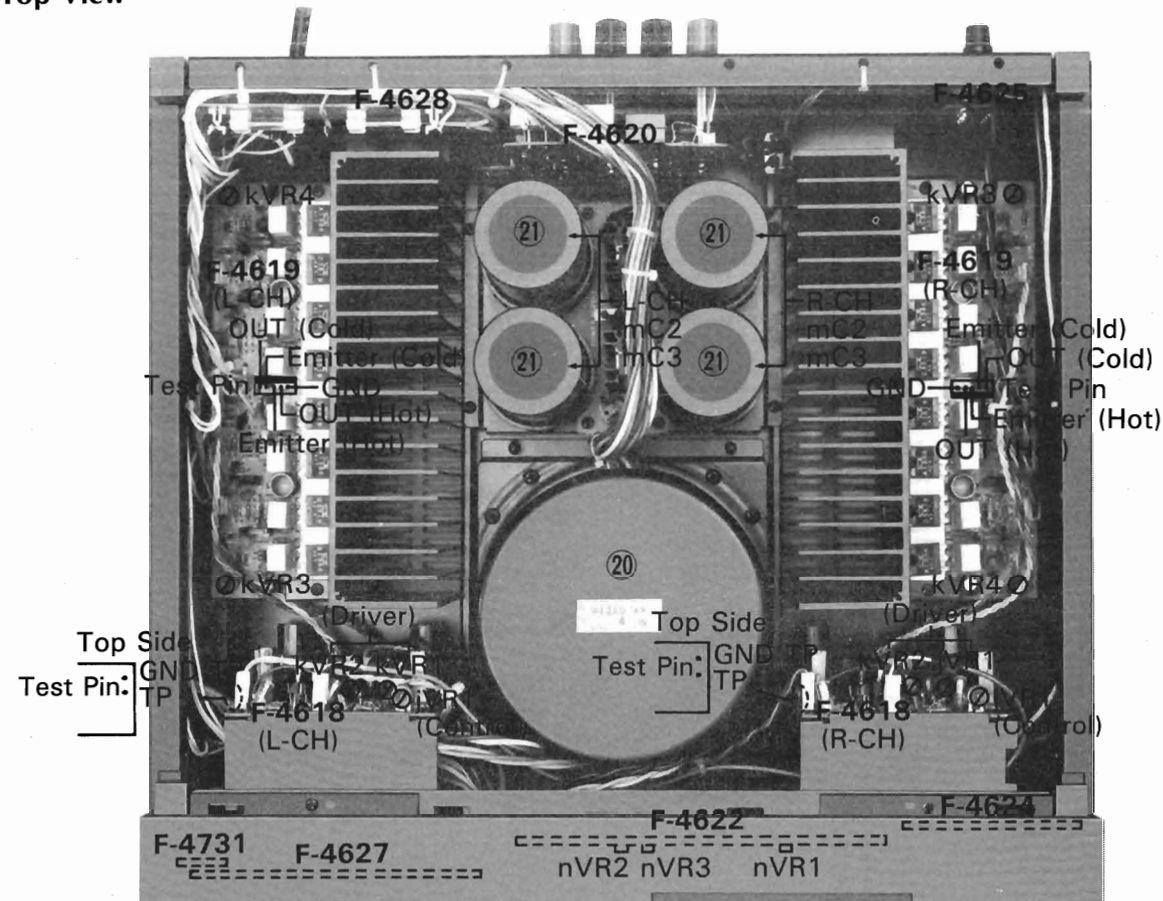

Parts List < Front, Top & Rear View >

Parts No.	Stock No.	Description
1	47656500	Side Panel Ass'y L-CH
2	47650600	Bonnet <XX, UL, CSA>
	47662300	Bonnet <EU>
3	47650800	Front Panel Ass'y
4	47650100	Dial Plate, edge light plate
5	47656400	Side Panel Ass'y R-CH
6	48112100	Rotary SW., ATTENUATOR
7	47649300	Knob, ATTENUATOR
8	47338400	Leg Ass'y
9	48112000	Push SW., SPEAKERS/PEAK HOLD/DISPLAY
10	47625000	Knob, Push SW.
△ 11	46612900	Push SW., POWER
12	47633700	Knob, POWER SW.
△ 13	07189600	AC Outlet <XX, UL, CSA>
△ 14	46161000	AC Outlet <EU>
△ 14	38004900	Power Supply Cord <XX, UL, CSA>

Parts No.	Stock No.	Description
△ 15	46128900	Power Supply Cord <EU>
16	39104900	Strain Relief
	46739400	Slide SW., SPEAKER INPEDANCE <XX, EU>
	46736600	Slide SW., SPEAKER INPEDANCE <UL, CSA>
△ 17	48062100	Slide SW., VOLTAGE SELECTOR <XX>
△	07204700	Slide SW., VOLTAGE SELECTOR <EU>
18	46739500	8P Speaker Terminal
19	22006100	2P INPUT Terminal
△ 20	15018201	Power Transformer <XX>
△	15018202	Power Transformer <UL, CSA>
△	15018205	Power Transformer <EU>
21	48149900	10000µF 95V E.C.

5. SCHAMATIC DIAGRAM

5-1. Power AMP Section

\* Design and specifications subject to change without notice for improvement.  
 \* La présentation et les spécifications sont susceptibles d'être modifiées sans préavis par suites d'améliorations éventuelles.  
 \* Änderungen, die dem technischen Fortschritt dienen, bleiben vorbehalten.

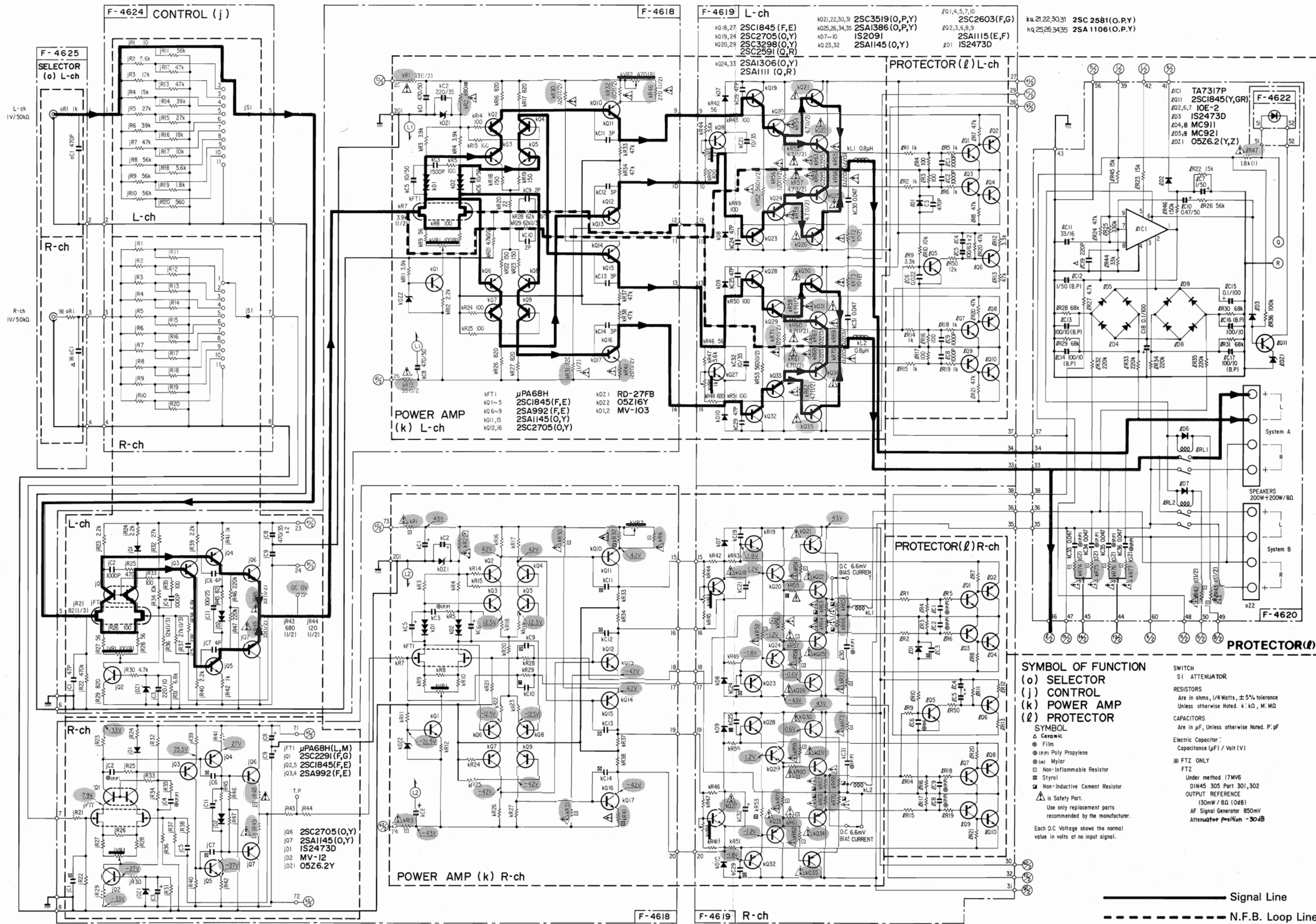

- SYMBOL OF FUNCTION**
- (o) SELECTOR
  - (j) CONTROL
  - (k) POWER AMP
  - (l) PROTECTOR
- SYMBOL**
- △ Ceramic
  - Film
  - ⊙ (P.P) Poly Propylene
  - ⊖ (M) Mylar
  - Non-Inflammable Resistor
  - ⊞ Styrol
  - ⊞ Non-Inductive Cement Resistor
  - ⚠ is Safety Part.
- SWITCH**
- S1 ATTENUATOR
- RESISTORS**
- Are in ohms, 1/4 Watts,  $\pm 5\%$  tolerance Unless otherwise Noted. k: k $\Omega$ , M: M $\Omega$
- CAPACITORS**
- Are in  $\mu$ F, Unless otherwise Noted. P: pF
  - Electric Capacitor
  - Capacitance ( $\mu$ F) / Volt (V)
  - \* FTZ ONLY
  - FTZ Under method 17M/6
  - DIN45 305 Part 301,302
- OUTPUT REFERENCE**
- 130mW / 8 $\Omega$  (10dB)
  - AF Signal Generator 850mV
  - Attenuator pos/neg -30dB
- Each D.C. Voltage shows the normal value in volts at no input signal.

- 2SA992
- 2SA1145
- 2SC1815
- 2SC1845
- 2SB527
- 2SD357
- 2SA1115
- 2SC2603
- 2SA1306
- 2SC3298
- 2SC2291
- 2SA1386
- 2SC3519
- 2SC2705
- TA7318P
- TA7317P
- M5218L
- LC7550
- RB152LFF
- UB152LFF
- MC921
- MC911
- 1S1588
- 1S2091
- 1S2473
- 10E-2
- SEL1110S
- $\mu$ PA68H-L
- 05Z9.1
- 05Z6.2E
- 05Z12
- 05Z13
- 05Z16
- 05Z24
- 05Z33
- RD27F

— Signal Line  
 - - - N.F.B. Loop Line

5-2. Power Supply & Peak Power Meter Section

• Design and specifications subject to change without notice for improvement.  
 • La présentation et les spécifications sont susceptibles d'être modifiées sans préavis par suites d'améliorations éventuelles.  
 • Änderungen, die dem technischen Fortschritt dienen, bleiben vorbehalten.

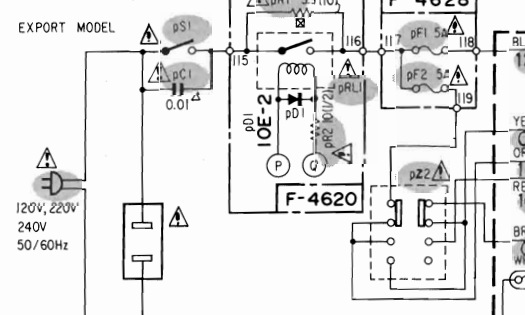
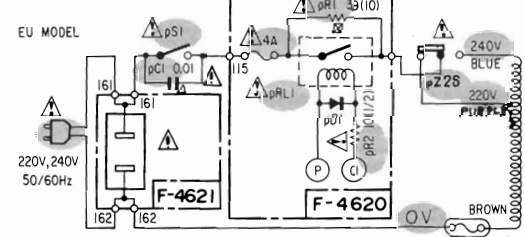
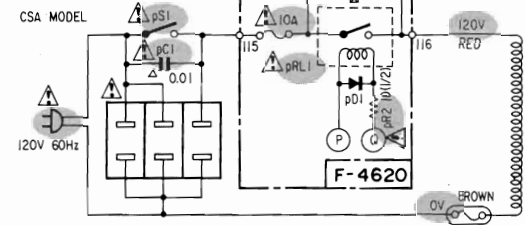
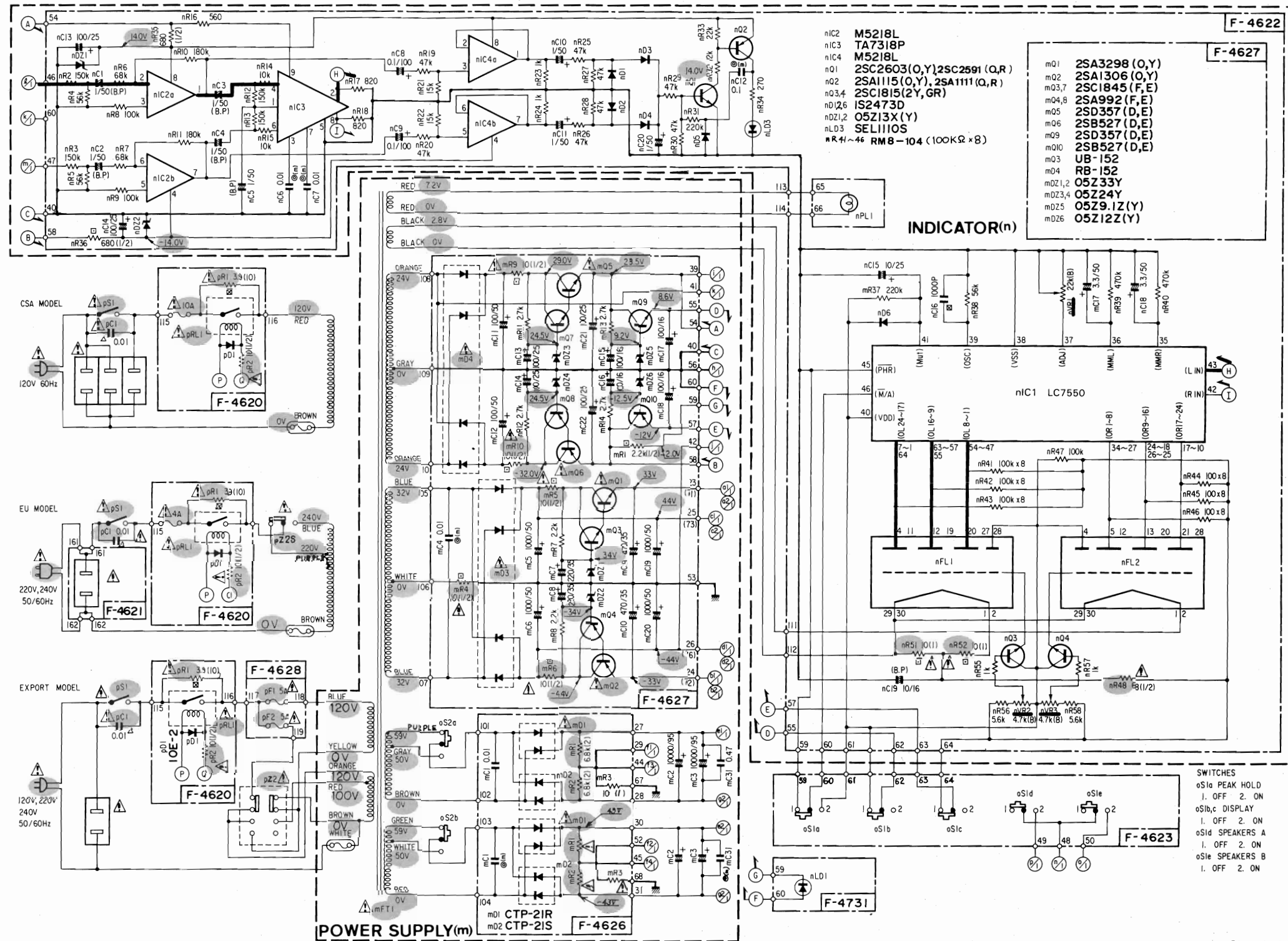

- nIC2 M5218L
- nIC3 TA7318P
- nIC4 M5218L
- nO1 2SC2603(O,Y), 2SC2591 (Q,R)
- nO2 2SA1115(O,Y), 2SA1111(Q,R)
- nO3,4 2SC1815(2Y,GR)
- nD1,2 IS2473D
- nD21,2 OSZ13X(Y)
- nLD3 SEL1110S
- nR4~46 RM8-104 (100KΩ × 8)

- mO1 2SA3298 (O,Y)
- mO2 2SA1306 (O,Y)
- mO3,7 2SC1845 (F,E)
- mO4,8 2SA992 (F,E)
- mO5 2SD357 (D,E)
- mO6 2SB527 (D,E)
- mO9 2SD357 (D,E)
- mO10 2SB527 (D,E)
- mO3 UB-152
- mO4 RB-152
- mD21,2 OSZ33Y
- mD23,4 OSZ24Y
- mD25 OSZ9.1Z(Y)
- mD26 OSZ12Z(Y)

- SWITCHES
- oS1g PEAK HOLD
  - 1. OFF 2. ON
  - oS1b,c DISPLAY
  - 1. OFF 2. ON
  - oS1d SPEAKERS A
  - 1. OFF 2. ON
  - oS1e SPEAKERS B
  - 1. OFF 2. ON

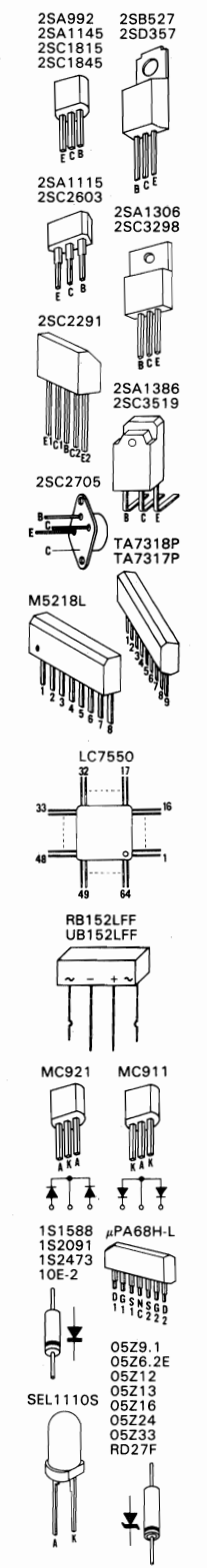

1  
2  
3  
4  
5

### 6. INTERIOR BLOCK DIAGRAM OF IC

•TA7317P (Speaker Protector IC)

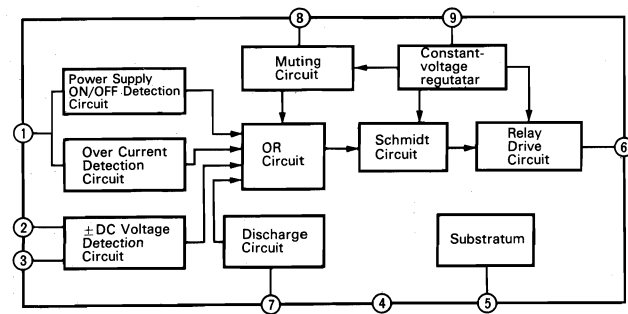

•M5218L (Audio Pre Amp. IC)

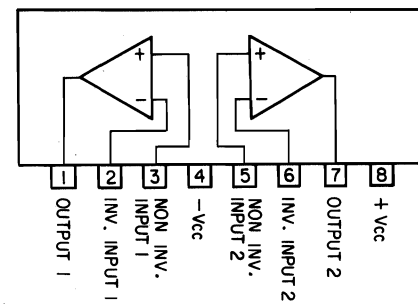

•TA7318P (Meter Drive IC)

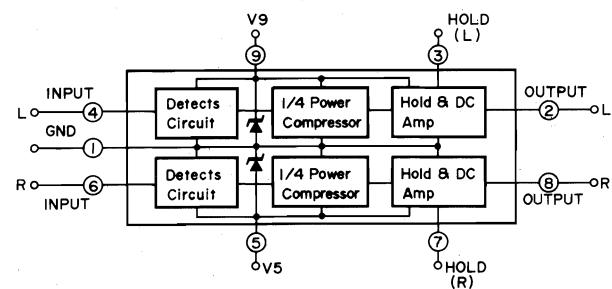

•LC7550 (Meter Drive & Peak Hold IC)

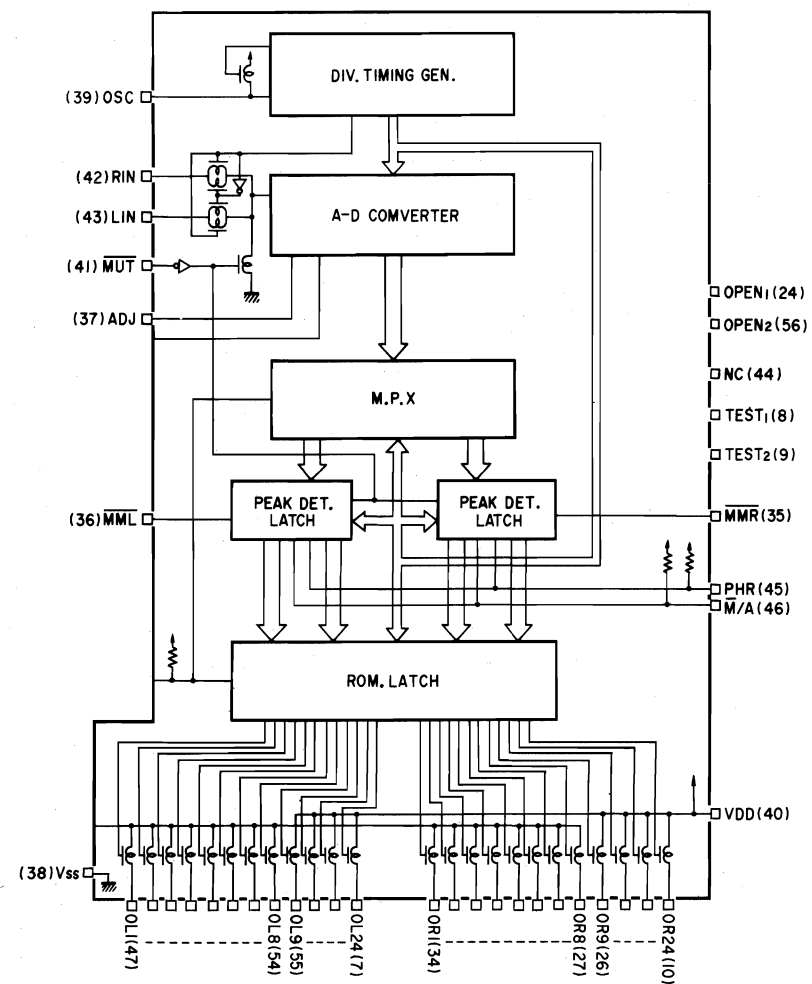

### 7. PACKING LIST

Parts No.	Stock No.	Description
1	91167720	Vinyl Bag
2	47332820	Styrofoam Packing
3	47624700	Carton Case

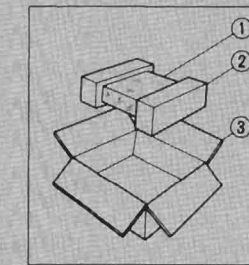

### 8. ACCESSORY LIST

Stock No.	Description
46958500	Operating Instruction

**Sansui**

SANSUI ELECTRIC CO., LTD.: 14-1, Izumi 2-chome, Suginami-ku, Tokyo 168 Japan  
 PHONE: (03) 324-8891/TELEX: 232-2076 (International Division)

SANSUI ELECTRONICS CORPORATION: 1250 Valley Brook Ave. Lyndhurst, N.J. 07071 U.S.A.  
 17150 South Margay Ave. Carson, California 90746 U.S.A.  
 3036 Koapaka Street, Honolulu, Hawaii 96819 U.S.A.

SANSUI ELECTRONICS (U.K.) LTD.: Unit 10A, Lyon Industrial Estate, Rockware Avenue, Geenford, Middx UB6, OAA, England  
 SANSUI ELECTRONICS G.M.B.H.: Pau Ehrich Strasse 8, 6074 Rödermark 2, West Germany